

Edward Brorein
Applications Specialist

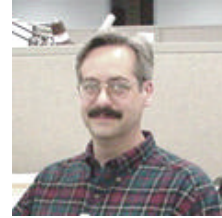

New Tools for Optimizing Operating Time of Mobile Wireless Devices



Agilent Technologies

Copyright © 2002 Agilent Technologies

Hello,

I am Ed Brorein, applications specialist for Agilent Technologies' Power Products. Welcome to our workshop.

Today I will be presenting how new tools and concepts for battery drain analysis are useful for optimizing the operating time of mobile wireless devices.

Challenges for the R&D Engineer

- **“I need to maximize the run time of my mobile wireless device”**
- **For example ...**
 - **Optimize power versus data rate by trying combinations of packet size, number of channels, or other operational parameters**
 - **Optimize power efficiency of digital baseband operation**
 - **Find and understand power-related anomalies that cause reduction in battery life**
- **The solution is Battery Drain Analysis**

Battery operating time continues to be a critical factor for mobile wireless device designs. In turn, the challenge for the R&D Engineer is “I need to maximize the run time of my mobile wireless device”. Unfortunately, simply using a larger battery is not usually a viable option.

Examples of tasks the R&D engineer is faced with when maximizing run time include:

- Optimizing power consumed versus data rate received or sent by trying various combinations of packet size or number of data channels versus duration of transmission in 3G and other mobile appliances.
- Similarly minimize power consumed in the digital baseband by optimizing its operation with respect to data access and processing operations and refresh rates.
- Find and understand anomalies in operation that draw excess power and cause reduction in battery life.

Battery current drain analysis is a very useful solution in optimizing battery operating time of wireless mobile devices.

Battery Drain Analysis for Optimizing Operating Time of Mobile Wireless Devices

To Validate Battery Life

- Estimate runtime under given operating conditions by ...
 - Measuring voltage rundown
 - Measuring average current

To Optimize Battery Life

- Perform Battery Drain Analysis
 - Characterize current out of the battery
 - Make tradeoffs in design that impact the current drain and battery life

Examples of Mobile Wireless Devices

- Mobile Handsets (2G / 2.5G / 3G)
- *Bluetooth*™ enabled devices
- Wireless LAN access devices
- PDAs

What do we mean by “battery drain analysis”?

Predicting, validating, and optimizing battery operating time usually entails several different test methods performed by the design team. It involves testing and characterizing the device and sub circuits, and the battery, both independently and in combination. All of these results are correlated and used in coming up with a final result for battery operating life. No one single approach provides a definitive answer.

At a more basic level, validating battery life is a black box treatment of the wireless device, usually in combination with the battery, measuring either the battery voltage or current, to determine operating time. Test guidelines use these methods to validate battery life.

Performing battery drain analysis is more than validating battery life. It is employing methods of characterizing current drain out of the battery. It provides insight into the operation of the device allowing tradeoffs to be made that impact current drain and battery life, and to optimize those trade for maximizing battery life.

Throughout this presentation mobile wireless devices, or handsets, will be regularly referenced. This actually encompasses a number of different battery powered devices, including 2G, 2.5G, and 3G handsets, *Bluetooth*™ enabled devices, and PDA's.

Battery Drain Analysis for Optimizing Operating Time of Mobile Wireless Devices

Today's Objectives

- Review traditional methods for validating battery life
- Discuss why traditional methods are inadequate for Battery Drain Analysis
- Show how Battery Drain Analysis is effective for characterization and optimization of battery operating time
- Highlight aspects of Battery Drain Analysis that drive the need for specialized capabilities for sourcing and measurement

We will start today by first reviewing the traditional methods employed for validating battery life. This will serve as a basis for describing a generic system platform and discussion why traditional methods and approaches are not quite adequate for battery drain analysis.

With the appropriate system platform we will show how battery drain analysis can be used and be effective for characterizing and optimizing battery operating time.

In many cases several needs of a platform for battery drain analysis are best addressed by utilizing equipment having specialized capabilities for sourcing and measurement more specifically suited for this application.

Agilent 14565A Device Characterization Software and 66319/21 Mobile Comm.'s dc Sources

- Sourcing & measurement solution for Digital Wireless Products
- Now features new enhancements specifically for long term battery drain measurement and analysis

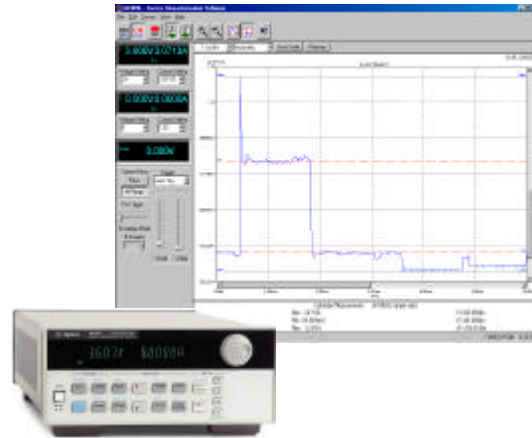

Battery Drain Analysis Copyright © 2002 Agilent Technologies

Page 5

More specifically, we have been providing the 14565A Device Characterization Software and 66319 and 66321 Mobile Communications dc Sources as a specialized sourcing and measurement solution ideally suited for characterizing the current drain of digital wireless products.

We recognized that additional specialized capabilities were required for optimizing battery runtime in R&D. We're pleased to announce we have created new enhancements to our platform specifically for long term battery drain measurement and analysis, which we will share with you during this training.

Traditional Method for Validating Battery Life: Voltage Run Down Time Test

- Using a fully charged battery, log voltage until device shuts down.
 - Example: CDG 35 Optional System Performance Tests

- Advantages

- Simple to implement
- Measuring voltage does not induce error
- Low sampling rate
- Supports dynamic operation

- Disadvantages

- Time consuming
- Depends on battery condition
- Only yields operating time

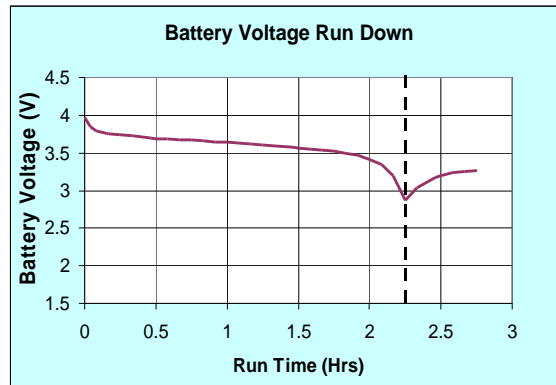

Battery Drain Analysis Copyright © 2002 Agilent Technologies

Page 6

One approach to validating battery operating life is by using a voltage run down time test. Basically, using a fully charged battery, place the device under test (DUT) into its appropriate operating mode to be validated. Data log the battery voltage against time as the DUT runs and finally shuts down. The voltage inflection point at 2.25 hours indicates how long the DUT ran before its low battery voltage shutdown occurred.

An example of this approach is the CDMA Design Guideline CDG 35 Optional System Performance Tests for determining battery operating time.

An advantage that it is relatively simple to implement. Voltage measurement is straightforward and does not affect accuracy of the result. Due to the slow rate of change of voltage only a low sampling rate is needed. Finally, as it is a full duration test it allows the user to run a benchmark type of test with dynamic operating conditions that simulate real world conditions, such as change in power due to distance, changes in information rates, etc.

One disadvantage is that the test is relatively time consuming.. Once started it is necessary to run to completion to determine operating time. Another disadvantage is that it depends on the state of the battery, which can vary considerably and not necessarily representative of a typical battery.

The only result is operating time. The DUT drain current and battery capacity remain unknown, leaving the operating time result questionable.

Traditional Method for Validating Battery Life: Current Drain Measurement

- Measure average battery drain current over a shorter, fixed time period
 - Operating time (hrs) = Battery Capacity (mA-hrs) / Avg Current (mA)
 - Example: GSM MoU Association PRD: TW.09 Test Procedure
- Advantages
 - Less test time
 - Yields time & current
- Disadvantages
 - High sampling rate
 - Depends on battery
 - Does not support dynamic operation
 - Current measurement can introduce error

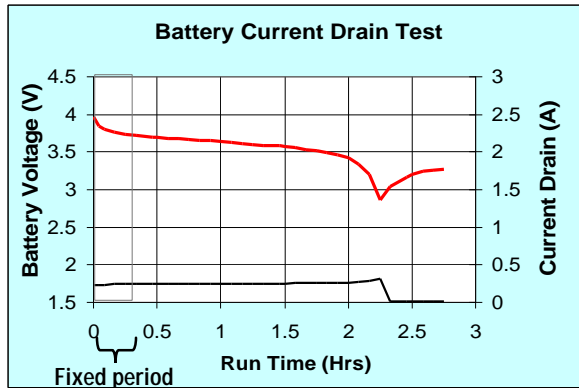

Battery Drain Analysis Copyright © 2002 Agilent Technologies

Page 7

An alternate method for validating battery operating life is by making a current drain measurement. Again using a fully charged battery, the DUT is placed into its appropriate operating mode to be evaluated. The average current drain is then measured for a defined period of time deemed representative of the overall run time. The operating time is then calculated by dividing the stated battery capacity in mA-hrs by the measured current drain in mA. An example of this approach is the TW.09 Test Procedure for GSM mobile phones.

The advantages include:

- Battery operating time is determined in much less time than the full run time.
- The average current drain is now known. Providing stated battery capacity is representative for the DUT loading, run time should be reasonably accurate.

The disadvantages include:

- Due to the high speed, high amplitude pulsed loading the current needs to be sampled at a high rate to assure an accurate average value is obtained. TW.09 specification recommends a 50 kHz sampling rate.
- Running a short duration test does not lend itself to running a long term benchmark type test utilizing a series of different operating conditions.
- Unlike making a voltage measurement, making current measurements are more difficult and, depending on the approach, can introduce error in the result.

A Generic System for Battery Drain Measurement and Analysis

- When configuring an instrumentation system to measure and analyze battery drain, the system must
 - Properly source power to the DUT
 - Log battery run down voltage
 - Accurately measure current from milliamps to amperes
 - Log DUT current from minutes to days in duration
 - Store all data for post test access
 - Provide a post test summary of basic results
 - Provide analysis of data for anomalies and design optimization

Basic Results

- Run time
- Average current
- Average voltage
- Amp-Hrs consumed
- Watt-Hrs consumed

Based on our review of the traditional methods of validating battery operating time and additional considerations for battery current drain analysis we can compile a list of requirements for a generic system for performing battery drain measurement and analysis.

- It must properly source power to the DUT.
- It should be able to log battery run down voltage for validating operating time.
- It must measure current from milliamps to ampere levels, which is typical of mobile wireless devices and their various operating modes.
- It needs to log the current drain from minutes to days in duration to address the variety of test scenarios that are likely to be encountered.
- It should provide a post test summary of basic test results: Run time, average current, average voltage, and Amp-Hrs and Watt-Hrs consumed.
- Analysis of the data is needed for identifying and understanding anomalies and optimize the design of the DUT.

A Generic System for Battery Drain Measurement and Analysis

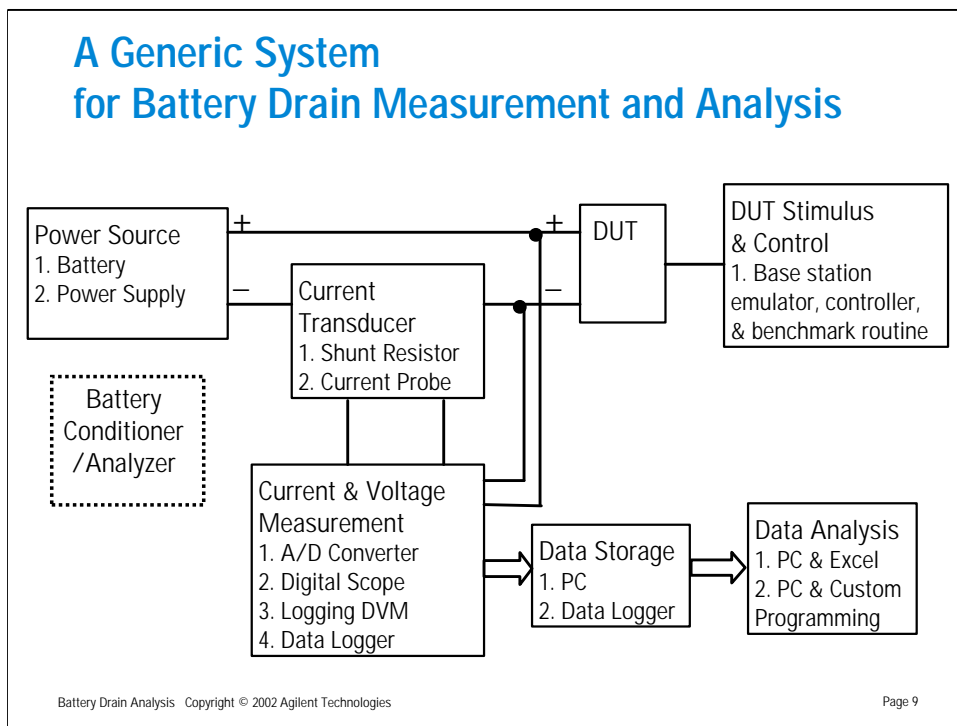

Based on the requirements the block diagram of the generic system is illustrated above. A number of different possible devices and/or equipment are listed in each of the blocks.

First a means for placing the DUT into an appropriate operating mode for the desired testing is needed. As one example for mobile phones a base station emulator is usually used to interact with and provide the necessary protocol for DUT operation.

Second a means of properly powering the DUT is required, whether it is a battery or a power supply. A power supply is useful for testing the DUT independently of its battery. Similarly a battery conditioner / analyzer is useful for validating the battery independent of the DUT.

A transducer for measuring the current without introducing error is needed.

Equipment to digitize and log the voltage and current signals over time is needed.

Finally, a system for storing the digitized test results and provide post test analysis is required.

These blocks each serve as discussion points of challenges of traditional solutions and enhancements and approaches that better support performing battery drain analysis.

We will start with the Power source.

Sourcing: Power Sources

Requirements

- Provides controlled power to the DUT

Traditional Solutions

- Battery
- General Purpose Power Supply

Challenges

- No control of voltage
- Best suited for Voltage Rundown Time Test
- Response of power supply is different from that of a battery
 - Slow transient response
 - Zero output resistance

Specialized Solution

- Power supply with fast transient response and battery emulation

The first block in the system diagram to discuss is the power source, which provides controlled power to the DUT.

As we already seen the battery is a traditional source of power for conducting run time validation testing. It makes a lot of sense to validate the run time of the DUT with the actual battery. However, a battery is not a controlled source and its voltage continually changes with use, temperature, charge, and so on. This really makes it best suited for the voltage run down test we described. Other testing is better served with a controlled voltage source.

A power supply is an alternate power source that provides a time-invariant controlled voltage. Remote voltage sensing allows the user to control the voltage right at the input of the DUT. This makes it very useful for validating the DUT independent of its battery.

However, the challenge of using a general purpose power supply is that its voltage response is different than that of a battery, due to slow transient response and having "ideal" zero output resistance.

The solution here is using a specialized source with fast transient response and settable output resistance so that it emulates the response of a battery.

Comparing a General Purpose Power Supply to a Specialized Power Supply

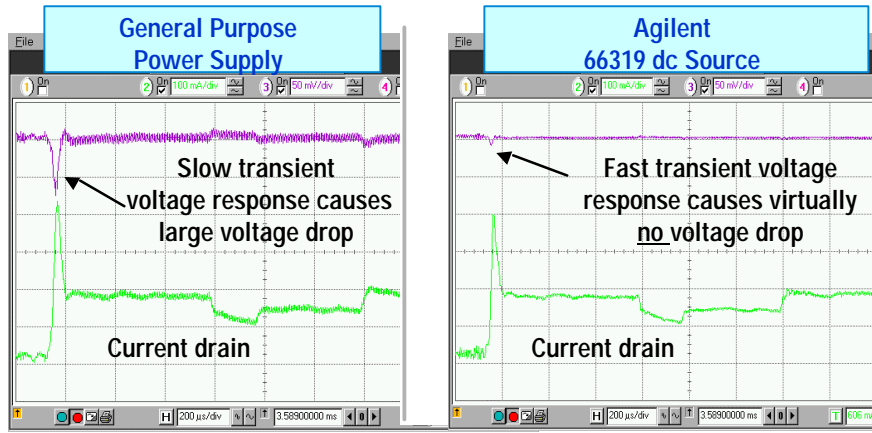

Transient Voltage Response when powering a *Bluetooth*[™] Headset

It is important to minimize any voltage drops when powering digital wireless devices running off of only 1 to 4 volts of bias.

A general purpose power supply is designed to provide stable dc power for a wide variety of loads and conditions. It typically has a large output capacitor to reduce output ripple voltage. These factors lead to the general purpose power supply having slow transient voltage response. As shown in the above oscilloscope screen capture for a general purpose (linear) power supply we measured about 80 mV of transient voltage drop in response to the pulse loading of a *Bluetooth* enabled headset. This was using relatively short 1 meter length of wiring, typical of a bench set up.

In comparison, when using a power supply that has fast transient voltage response, specifically for powering digital wireless devices, the transient voltage drop is greatly reduced. Shown here using the Agilent dc source the transient voltage drop was reduced to about 12 mV.

Battery Resistance Influences a Device's Runtime

- Most devices draw higher current as voltage drops
- Battery resistance causes voltage drop when sourcing current
 - Increases current drain
 - Earlier low V shutdown
- A dc source maintains full voltage when sourcing current
 - No increased current, so current drain is lower than with a battery
 - Estimated run time is longer than actual

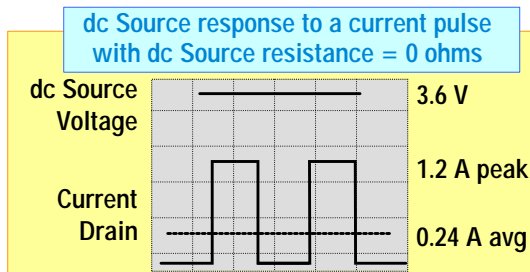
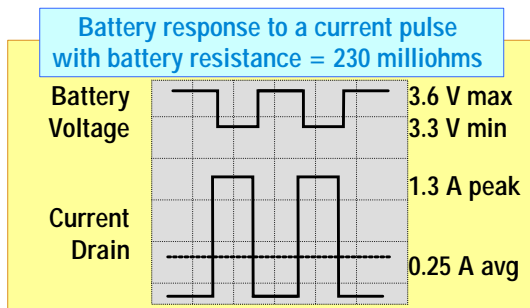

Battery Drain Analysis Copyright © 2002 Agilent Technologies

Page 12

Shown above are the loading characteristics a GSM mobile phone, comparing performance when powered by an actual battery versus a power supply.

Many mobile devices draw higher peak and average current to offset the lower operating voltage, as seen here.

In the upper graph when powered by a battery the voltage drops by almost 300 mV in response to the GSM phone transmit burst current, due to the battery resistance. This response increases the current drain by about 5%.

Another impact is the peak voltage drop will cause the mobile phone to reach its low voltage shutdown earlier.

In comparison, in the lower graph, the result of testing with a power supply with zero output resistance is the current drain is about 5% lower than what would be experienced in actual use with a battery. The exact difference does depend on the design of the particular mobile phone.

As a result, the operating time using a power supply with zero output resistance can be higher than when using an actual battery.

Comparing a Battery to a Specialized Power Supply

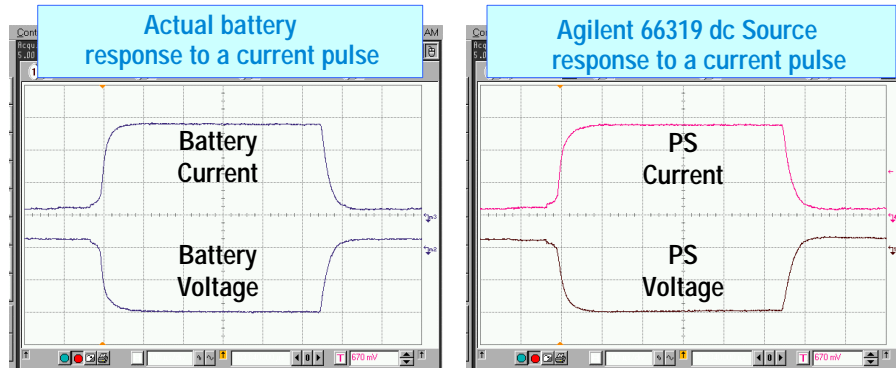

Battery resistance
is 170 milliohms

Power supply resistance
programmed to 170 milliohms

Performance is the same as when using a battery

Battery Drain Analysis Copyright © 2002 Agilent Technologies

Page 13

A battery is not an ideal voltage source. As shown here by the oscilloscope screen capture, a battery's output voltage drops in response to its load current, due to the battery's internal resistance.

In addition to having fast transient voltage response, a power supply must have programmable output resistance to emulate the internal resistance and voltage response of a battery.

Shown in the second oscilloscope screen capture is the voltage response of the Agilent dc source with its output resistance programmed to match the battery's internal resistance of 170 milliohms. As observed, the Agilent dc source's voltage response performance is the same as that of the battery.

In many ways the power supply is actually better than the battery. Unlike the battery the dc source's output voltage and output resistance is controllable and time invariant. This is important and useful in performing battery current drain analysis. Controlling and keeping the source fixed over time removes it from the list of variables when conducting controlled trials and comparisons between different devices and design changes!

Measurement: System Current Transducer

Requirements

- Measurement range: 1 A max for standby mode; 5 A max for active mode
- Measurement accuracy: 0.2 % of full scale

Traditional Solutions

• Current shunt

• Current probe

Challenges

- TW.09 specifies 0.5 ohms & 0.1 ohms
Yields 0.5 V drop -- unsuitable for 4 V battery
- Ideally use 0.025 ohm & 0.005 ohms
Yields 25 mV drop -- suitable for even a 1.2 V battery
- Thermal EMF can create a large offset errors
- Need to address grounding and common mode errors
- Requires periodic re-calibration for offset and drift
Creates difficulties when running long tests

Specialized Solution

- Power supply that incorporates accurate current measurements

Battery Drain Analysis Copyright © 2002 Agilent Technologies

Page 14

Now that we are able to source current we now need to measure it. Typical requirements dictate needing two measurement ranges for testing standby and active mode current drains. The pulsed current drain nature with high peak but relatively low dc average requires relatively high measurement ranges with very good full scale accuracy in order to assure adequate accuracy at the lower average value. Typically a 1 amp range is needed for standby and a 3 to 5 amp range for active operation, with a basic accuracy of 0.2% of full scale.

The first traditional solution is a current shunt. Similar to the issue we just discussed with transient voltage drop, the dc voltage drop is a problem with shunts. The GSM TW.09 specification calls out for 0.5 ohms and 0.1 ohms for standby and active mode testing. Depending on peak currents and operating voltage, this could present a challenge, especially for lower battery voltages. Assuming the peaks are as high as 1 amp and 5 amp respectively, the shunt voltage drop would be 0.5 volts peak. This would not be well suited for battery voltages under 4 volts.

A general recommendation here would be to use very low value shunts that introduce no more than 25 mV drop for each volt of battery bias to make the shunt influence negligible.

Other problems with using shunts is that thermal EMF voltages can introduce large offset errors and grounding and common mode signals need to be address or likewise can introduce errors.

A second traditional solution is a clamp on dc current probe. This has the advantage of having negligible voltage drop but require periodic recalibration for offset drift.

When using a dc power supply, a specialized source incorporating the current measurement internally resolves many of the challenges of using an external current transducer.

Measurement: System Digitizer

Requirements

- Sample current at 50 kHz or faster to accurately capture sub-millisecond pulses and anomalies

Traditional Solutions

- High-speed Multiplexing A-to-D Converter with deep memory
- Multiplexer and fast DVM with deep memory
- Digital oscilloscope with deep memory
- High-speed data logging and storage system

Challenges

- High-end data logging & storage solutions can be expensive
- Lower-end solutions require a lot of custom configuring
- High-speed data transfer over long periods is challenging

Specialized Solution

- Power supply with integrated high-speed digitizing measurement system

The system digitizer measures the current shunt voltage and bias voltage to the DUT and converts it to a digital data (A to D conversion) for storage and post processing. To accurately capture sub-millisecond pulses and anomalies characteristic of digital wireless devices you typically want to sample at a 50 kHz or faster rate (the GSM TW.09 specification calls out for 50 kHz sampling).

Traditional solutions include high speed A to D converters, sampling DVMs, and digital oscilloscopes, all usually with a deep buffer memory for caching the high speed data.

There are also some dedicated high speed data logging and storage systems available. However, this higher end solution can be fairly expensive.

Additional challenges for lower end solutions is that they may require quite a bit of additional effort custom configuring them for the particular application. Also high speed data transfer can become a problem with lower end solutions and GP-IB equipment when testing runs for an extended period of time or continuously.

A power supply integrating a high speed digitizing measurement system is another, specialized, alternate solution for digitizing the measurements while powering the DUT.

Specialized Solution for Measurement: Agilent Mobile Communications dc Sources

- **Simplifies Battery Drain Measurement and Analysis System by eliminating the need for separate measurement instrumentation**
- **Accurate Current Measurement**
 - Multiple current ranges (5 A, 1 A, and 0.02 A) for Active, Standby, and Low-power modes
- **High-Speed Digitizing System**
 - High-speed DSP, 16-Bit, 64 kHz ADC and 4,096 byte buffer
 - Continuously digitized waveform with flexible triggering
- **Waveform Measurement**
 - DSP-calculated RMS, High, Low, Minimum, Maximum values
 - Graphical User Interface Software to visualize results

The Agilent 66319/66321 Mobile Communications DC Sources use a unique high speed DSP based digitizing measurement system, much like that of a digital oscilloscope.

There are three DC current ranges to provide accurate active, standby, and off mode current measurements, specially tailored for digital wireless device testing.

It features a high speed 16 bit, 64 kHz ADC with 4,096 byte buffer with a very flexible triggering system like that of a digital oscilloscope.

The DSP based measurement system includes several calculated measurement functions. It is further supported by our Device Characterization Software, a graphical user interface that provides digital oscilloscope-like measurement capability.

The Agilent dc Source Measuring Current and Voltage When Using a Battery as the Source

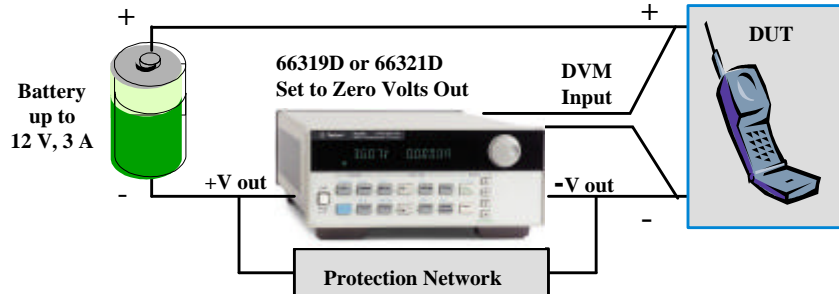

- When programmed to zero volts the power supply becomes a zero-ohm shunt
- Optional DVM input (on D suffix models) can be used to log battery voltage
- An external network protects against battery over-currents from misapplication
- Application note to follow

Battery Drain Analysis Copyright © 2002 Agilent Technologies

Page 17

Although the 66319/21 is designed as a source for powering wireless mobile devices directly, independent of its battery, with some additional steps it can also be used as a measurement instrument when powering the mobile device from its battery.

When the output is programmed to zero volts the power supply becomes a zero ohm shunt and precision current measurement system, which can be connected in series with the battery and Device Under Test.

- As a zero ohm shunt there are no voltage drop problems, unlike traditional current shunts.
- The built-in precision current measurement provides dynamic range that is needed for wireless battery powered devices, unlike traditional measurement methods.

The optional DVM input on the D suffix models allows the power supply to optionally log the battery run-down voltage and additionally support watt-hour consumption measurement.

Because a battery has virtually unlimited current capability, an external protection circuit, consisting of a few passive components, is needed to protect the DUT and power supply against certain fault and misapplication conditions.

An application note detailing how to use this dc source for this mode of operation will be forthcoming.

Analysis: System Data Storage and Analysis

Requirements

- Store from minutes to days of high speed digitized data
- Provide a run time summary and post test analysis of basic results
- Analyze data for anomalies (unusual pulses & random overloads)

Traditional Solutions

- PC and disk drive
- Data logger with storage
- Spread sheet software
- Search routines for anomalies

Challenges

- High end data logger can be expensive
- Too much data → Cannot open the file!
- Developing analysis routines can be time consuming

Specialized Solution

- Software that provides data reduction, storage, and visualization tools

The system data storage and analysis requirements include the ability to record and store the high speed digitized data from minutes to days in duration, based on the particular test requirement.

It should be able to provide a run time summary and post test analysis of basic results. Run time results include; average current and voltage, and amp-hours and watt-hours consumed.



It should be able to analyze the data to identify anomalies. The most common anomalies for digital wireless device worth pointing out include unusually high or long pulses of significant occurrence to affect drain, as well as the infrequent, random overload spikes that can cause premature device shutdown due to battery voltage droop.

Traditional solutions include PC and disk drive, or a high end data logger, for storage. Commercial spread sheet software packages are typically used for analysis, and custom programmed routines are typically written in the effort of searching for anomalies.

Like before, a commercial data logger system with storage can be relatively expensive. In most all cases the problems everyone runs into is "Too much data!" Tests that run for hours to days create massive amounts, up to Gigabytes, of data! Files this size become impractical. In practice, tests employing high speed data capture are run for only minutes in duration as a result.

The key here is to create a solution that first processes and reduces the data, and then provide storage and analysis capabilities.

Specialized Solution for Analysis: Agilent 14565A Device Characterization Software

- Works with Agilent Mobile Communications dc Sources to give easy-to-use graphical front panel
- No programming required to source, measure, and analyze
- Three modes of operation
 - Waveform Capture and Analysis
 -  • Data Logging and Analysis
 -  • CCDF Statistical Distribution Capture and Analysis

Introducing 2 new capabilities for capture and analysis of data
Ideal for measuring battery drain currents over long operating periods
(from hours to days to weeks)

The Agilent 14565A Device Characterization Software is an easy-to-use graphical front panel for the Agilent Mobile Communications dc Sources. It runs on a PC to provide source control, measurement and analysis without resorting to any programming.

In addition to the original waveform capture and analysis operating mode we now have added two new capabilities specifically for measuring and analyzing battery drain currents over long operating periods. These two new modes are data logging and analysis and CCDF Statistical Distribution Capture and Analysis.

We will discuss the techniques that two new modes employ to process and reduce the data to meaningful results as it is being captured.

Agilent 14565A Waveform Capture and Analysis

- Oscilloscope-like view of battery current drain
- Measurements permit estimating operating time and current drain
- Measurements include average, pulse high and peak levels, and timing values
- Zoom and markers for analysis

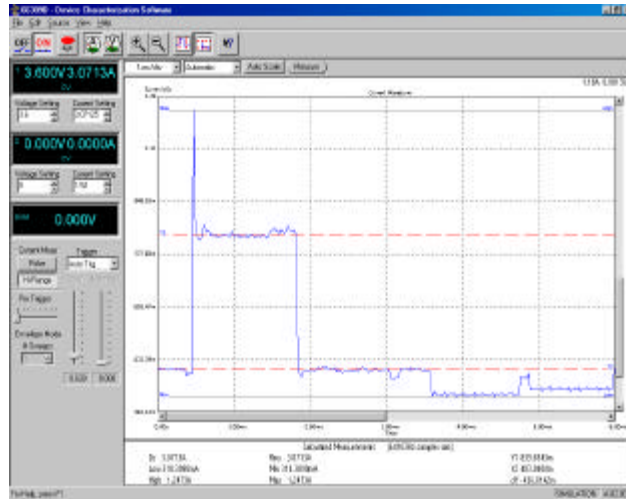

14565A Device Characterization Software displaying a GSM current waveform

The original 14565A operating mode for Waveform Capture and Analysis provides an effective means of capturing and displaying an oscilloscope-like view of the battery current drain over a short period of time. Built in measurement functions include average, pulse minimum, low, high, and maximum values. Zoom and marker controls provide timing and value measurements on various parts of the waveform.

These capabilities permit making basic estimates and analysis on battery current drain and operating time.

Agilent 14565A Data Logging and Analysis

- Logs from 10 seconds to 1000 hours
- Captures details with current sampled at 64 kHz
- Voltage can be optionally sampled at low rate
- Displays
 - Min, Max, and Avg current, voltage, and power
 - Run time, AH, WH
- Zoom and markers
- Integrating feature reduces data in real time

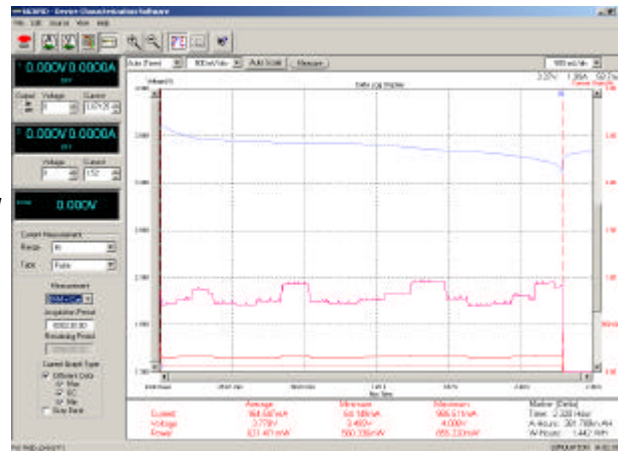

14565A Device Characterization Software displaying a long-term data log

Battery Drain Analysis Copyright © 2002 Agilent Technologies

Page 21

The first of the two new operating modes of the 14565A Software is Data Logging and Analysis. When in this mode it will log data from 10 seconds to 1000 hours. Over this duration the Agilent power supply continuously samples the current at a 64 kHz rate to capture high speed details and random overloads. Voltage can be optionally sampled every 10 seconds to 10 minutes to support average voltage and watt-hour measurements.

The above display screen shot capture displays minimum, maximum, and average currents, and average voltage waveforms over time. This is illustrating running the DUT with dynamic sequence, changing active output power levels, then switching through other operating modes (standby, off, active) as a type of benchmark to compare other devices against, for example. Numerical values displayed include minimum, maximum, and average current, voltage, and power. Cumulative values include run time, Amp-Hours and Watt-Hours.

Zoom and marker controls again allow the user to analyze sub sections of the data log.

Most importantly the integrating feature employed reduces the data to meaningful and manageable results as it is captured in real time.

Integrating Feature Reduces Data in Real Time

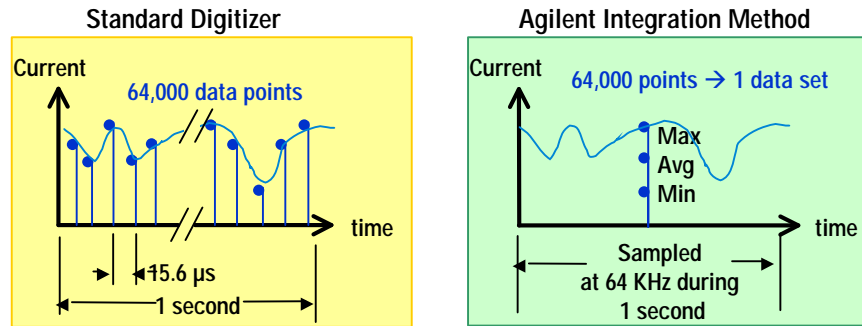

- Up to 1 second integration period provides a minimum, maximum, and average value for each period of 64 kHz sampled data.
- Manageable data files for post analysis and export (5 MB per 100 hours)
- Does not require high-speed data streaming to a PC
- Logs data to the disk to reduce loss of test data if test is interrupted

Battery Drain Analysis Copyright © 2002 Agilent Technologies

Page 22

How does the integrating feature in the data log operating mode work?

In a traditional approach, when sampling at a 64 kHz rate, one ends up with 64,000 data points at the end of a 1 second period.

In comparison, with the integrating method we use, each up to one second long integration period provides a minimum, maximum, and average value for each period of the 64 kHz sampled data. This effectively provides up to a 64,000 times data reduction, taking place real-time in the instrument.

The reduced data provided is more meaningful as it captures the relevant average and peak values. Tracking the peak provides a way of identifying infrequent, random (thus hard to capture) overloads that could cause early low battery shutdown.

The reduced data is now more manageable for storage, post analysis, and export, requiring about 5 MB for <100 hours and another 5 MB for each subsequent 100 hours. There is no need to have high speed data streaming to a PC now.

Lastly, the system logs the data to the disk drive to prevent loss of data in the event that the test is inadvertently interrupted.

Characterizing Complex Currents in the Time Domain

- Digital communications systems signals are complex & random in the time domain
 - Example: 3G
- Difficult to obtain meaningful average current values for estimating battery life
- Difficult to identify effect of design changes on current drain
- A better way to analyze is using a statistical distribution such as a Complementary Cumulative Distribution Function (CCDF) graph

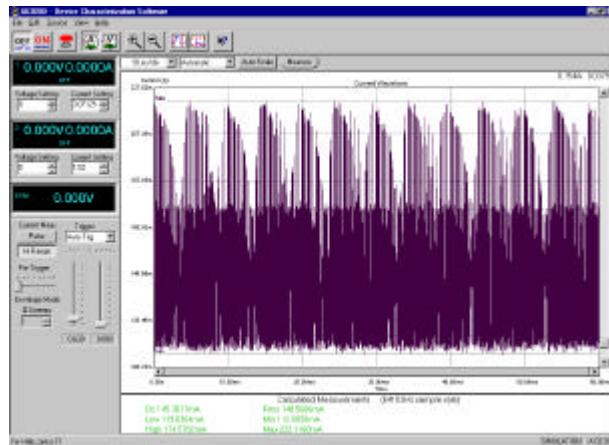

14565A Device Characterization Software displaying a CDMA2000 Power Amplifier Current Waveform

Battery Drain Analysis Copyright © 2002 Agilent Technologies

Page 23

Newer digital communications systems, such as 3G, use complex modulation formats with high levels of amplitude modulation for transmitting higher data rates. The resulting current drain waveforms are complex and unpredictable when viewed in the time domain. Shown above in the screen image is the 14565A capturing the current drain of a handset CDMA2000 RF power amplifier transmitting 3 data channels with respect to time.

The current drain similarly gets more complex and unpredictable when run over long periods of time typical of a battery operating time test.

As a result it becomes more difficult to predict average and peak values for estimating battery operating time or easily observe the effects of design changes on current drain when trying to optimize for battery operating time.

A better way to visualize and analyze complex current drain patterns is to examine their statistical distribution, such as with a CCDF graph.

Does everyone know what CCDF stands for? It stands for Complimentary Cumulative Distribution Function. It is very likely that you have encountered it as a useful way to characterize power output of RF amplifiers.

Agilent 14565A CCDF Capture and Analysis

- Displays current or voltage on x-axis versus % occurrence on y-axis
- **Horizontal** shifts indicate amplitude related changes
- **Vertical** shifts indicate time related changes
- Zoom, markers, save, recall and compare for analysis
- Accumulates from 10 seconds to 1000 hours
- Captures details with current sampled at 64 kHz

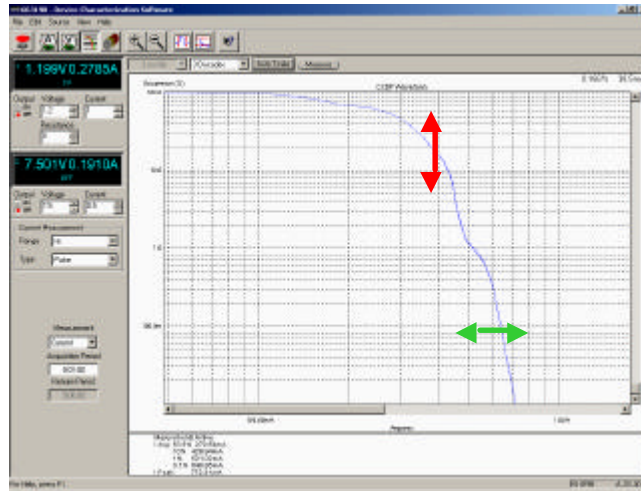

14565A Device Characterization Software displaying a CCDF for a *Bluetooth*[™] enabled headset current drain

Battery Drain Analysis Copyright © 2002 Agilent Technologies

Page 24

CCDF is the second, new operating mode we have added to the 14565A software for long term current drain measurement. CCDF can be used to quantify and analyze the dc current drain of a digital wireless device for the purpose of optimizing its operation for battery life.

A CCDF graph is an alternate form of a histogram. It displays the current or voltage on the x-axis versus its % of occurrence on the y-axis. One advantage of CCDF is it expands the higher amplitude current, which is the area of interest.

- Horizontal shifts indicate changes in amplitude, such as the device drawing higher or lower peak pulsed current.
- Vertical shifts indicate time related changes, such as the device drawing wider or a greater number of current pulses than expected for a given operation.

Zoom and marker controls provide means for measurement and analysis of the CCDF graph.

Save, recall, and compare and quantify changes of different CCDF graphs provides useful analysis capabilities to analyze design changes for design optimization.

In CCDF mode current or voltage is continuously accumulated over a period of 10 seconds to 1,000 hours. Data is sampled at 64 kHz to capture and characterize high speed details of the signal. It accumulates and builds the CCDF internally. There is no need for high speed data streaming or storage of large data files.

Summary: Benefits of Battery Drain Analysis

- **Allows you analyze and optimize designs for maximum battery runtime**
- **For example, provides a means to ...**
 - **Quantify changes in operational parameters (examples: packet size, number of channels) to optimize power versus data rate**
 - **Quantify changes in digital baseband operation to optimize power efficiency**
 - **Capture and analyze the effects of random anomalies such as unusually high or long pulses; random overloads**
 - **Determine dynamic power requirements of battery and power management circuit**

To summarize, employing battery current drain analysis tools and techniques in your battery life testing allows you to analyze and optimize designs for maximum battery runtime.

Some examples include:

- Quantifying differences in current drain due to changes made in data transmission, such as changing packet size versus the number of packets, or changing the number of data channels versus transmit time to better optimize the power drain and operating life vs. data rate.
- Likewise differences in current drain can be quantified due to changes made in the digital base band operation in processing data, to optimize power efficiency of data processing.
- Anomalous behaviors can be identified and their effects on power consumption quantified. Anomalies include unusually long or high pulses and random overloads which lead to early low voltage shutdown and reduced battery operating time.
- Quantifying the current drain distribution is useful for determining the dynamic power and current requirements for selecting the appropriate battery and power regulation and management circuits.

Summary: Agilent's Solution for Battery Drain Analysis

- Agilent Model 66319B, 66319D, 66321B, or 66321D dc Sources + Option 053 Adds 14565A Device Characterization Software with Battery Drain Analysis
 - Power source that simulates a battery
 - Integrated, high-accuracy measurement
 - Option 053 is a specialized solution for Battery Drain Analysis
-  Continuous long-term measurement with intelligent data processing and reduction
- Visualization tools to help you identify anomalies and optimize your designs
- For further information
<http://www.agilent.com/find/batterydrainanalyzer>

To close, the Agilent Mobile Communications dc Sources with option 053 adds 14565A Device Characterization Software making it a specialized solution for performing battery drain analysis.

This solution features:

- Power sourcing with fast response and programmable output resistance to simulate the performance of a battery.
- An integrated high-accuracy, high speed digitizing measurement system ideally suited for testing wireless digital battery-powered devices. It eliminates the need for and problems current shunts and probes.

Now, with option 053 new capabilities for battery drain analysis provide:

- Continuous long-term battery drain measurement with intelligent data processing and processing taking place real time in the instrument to produce meaningful and manageable results for effective battery drain analysis.
- Two new modes of operation in the Graphical User Interface, data logging and CCDF statistical distribution capture, to help you analyze and identify anomalies to optimize your designs for battery operating time.

The product data sheet and additional information can be found at this web site.